

WIRING

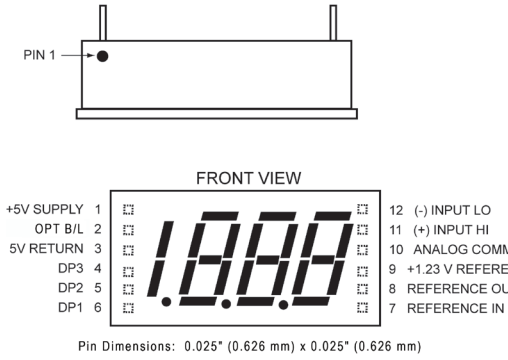

DIMENSIONS

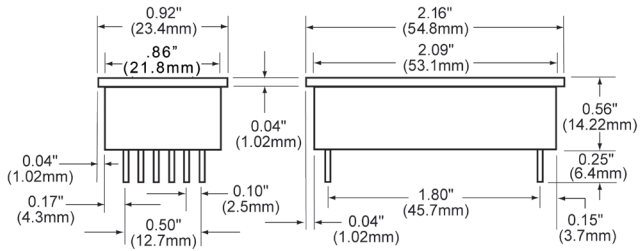

FRONT VIEW CALIBRATION POTENTIOMETER HOLE LOCATION

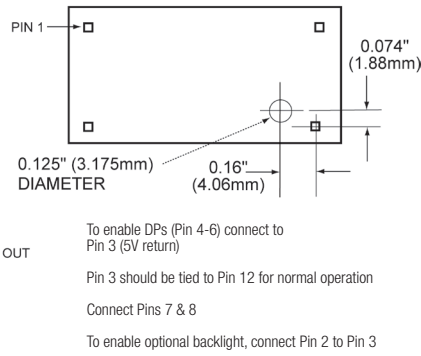

CUTOUT & BEZEL ASSEMBLY

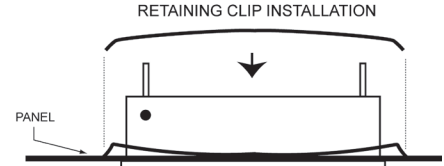
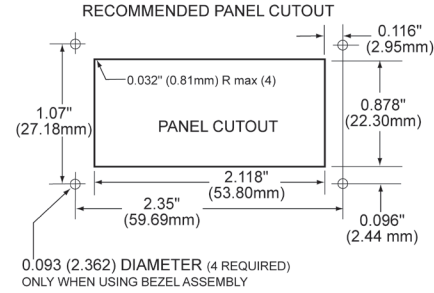
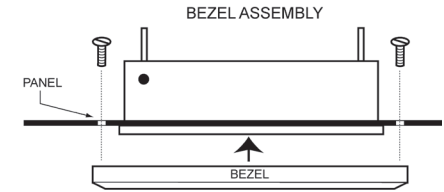
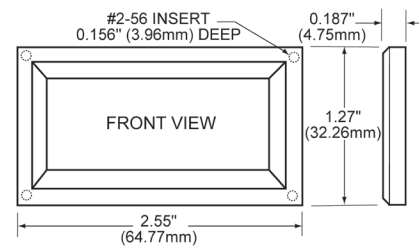

IS-054

Rev. 2J17

WIRING

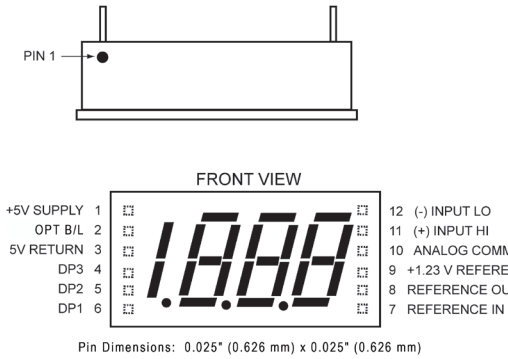

DIMENSIONS

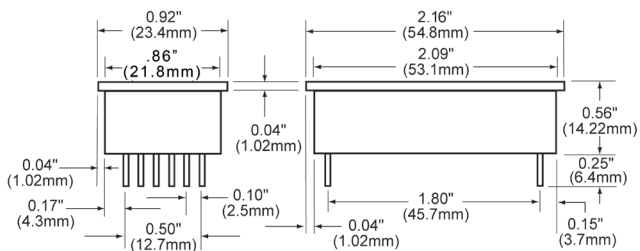

FRONT VIEW CALIBRATION POTENTIOMETER HOLE LOCATION

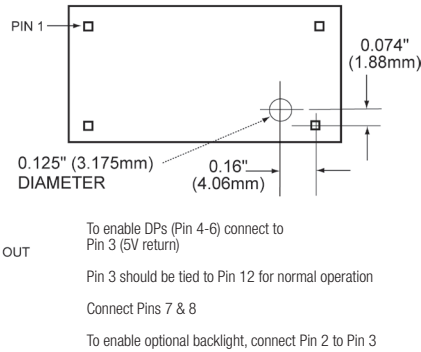

CUTOUT & BEZEL ASSEMBLY

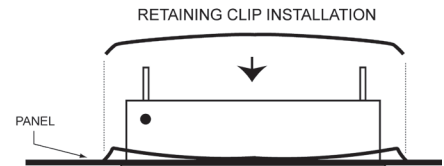
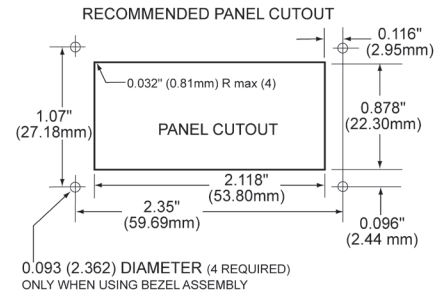
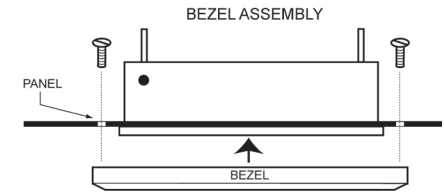
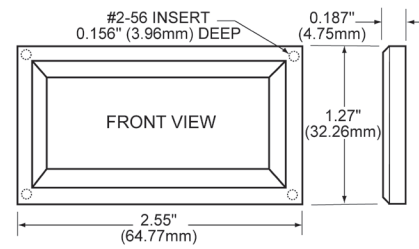

IS-054

Rev. 2J17